



TECHNOLOGY ENHANCING DESIGN

State of the art stainless steel architectural solutions

The background of the entire page is a photograph of a modern architectural structure made of stainless steel, featuring a complex, curved, and perforated design. It spans across a river, with lush green trees and a historic building visible on the opposite bank under a cloudy sky. Two large blue triangles are overlaid on the image, one on the left and one on the right, framing the central text.

ANDRITZ



APPLICATIONS

GRATINGS, RAILINGS, AND FENCES	6
CLADDINGS, VISUAL COVERS, AND SUN PROTECTION	8
INTERIOR ENHANCEMENTS	10
VENTILATION COVERS	12

DESIGN AND TECHNOLOGY

TECHNICAL SOLUTIONS	14
DESIGNS	16
FRAMES	17
SHAPES	18
FINISHES	20
FIXTURES	22



ANDRITZ ARCHITECTURAL SOLUTIONS

- High-quality materials
- Computer precision manufacturing
- Non-corrosive: weather and sun resistant
- Easy to install, maintain, and clean
- Long lasting
- Made from sustainable material,
- 100% recyclable
- Made in the EU

From industrial products to aesthetical pleasing architectural design

TECHNOLOGY THAT ENHANCES DESIGN

From a purely technical perspective, a building is a complex combination of physics, technologies, materials, and skills that result in a structure that serves a specific function. From an aesthetic view, a building can be awe-inspiring, magnificent, imaginative, and beautiful. This transition from functional

technically engineered buildings into aesthetically pleasing structures is quite often a challenge for ambitious architects and engineers. The goal is to achieve a pleasing balance between physical properties and aesthetics. That is what ANDRITZ strives to achieve for architects, designers, and constructors:

“Technically superior building components that are simultaneously striking, stylish, and beautiful.”

ENHANCED SOLUTIONS THROUGH EXPERIENCE

Our subsidiary, ANDRITZ Euroslot, is a designer and high-quality manufacturer of stainless-steel building components that fulfill an architect's vision and a constructor's requirements for precision and efficiency. Our facilities are ISO certified and computer-controlled. But, we are not just content to combine wires and support rods, form and finish pieces of stainless steel. We are passionate about our work and laser-focused on delivering. Even though we were the pioneer in developing wedge wire products for architectural purposes (the first application being the "Bibliothèque de France" in the 1990s), we never stop learning and fulfilling.

SUSTAINABILITY

We advocate using „green“ and sustainable architectural elements. Our products are manufactured exclusively from 100% stainless steel without any welding consumables. Steel, the most widely recycled material in the world, can be reused without any losses for an unlimited amount of times, which saves CO₂ and resources. As a consequence, you have not only a durable, but also a contemporary material. Even after teardown, our components are not cost-intensive debris, but a valuable resource.



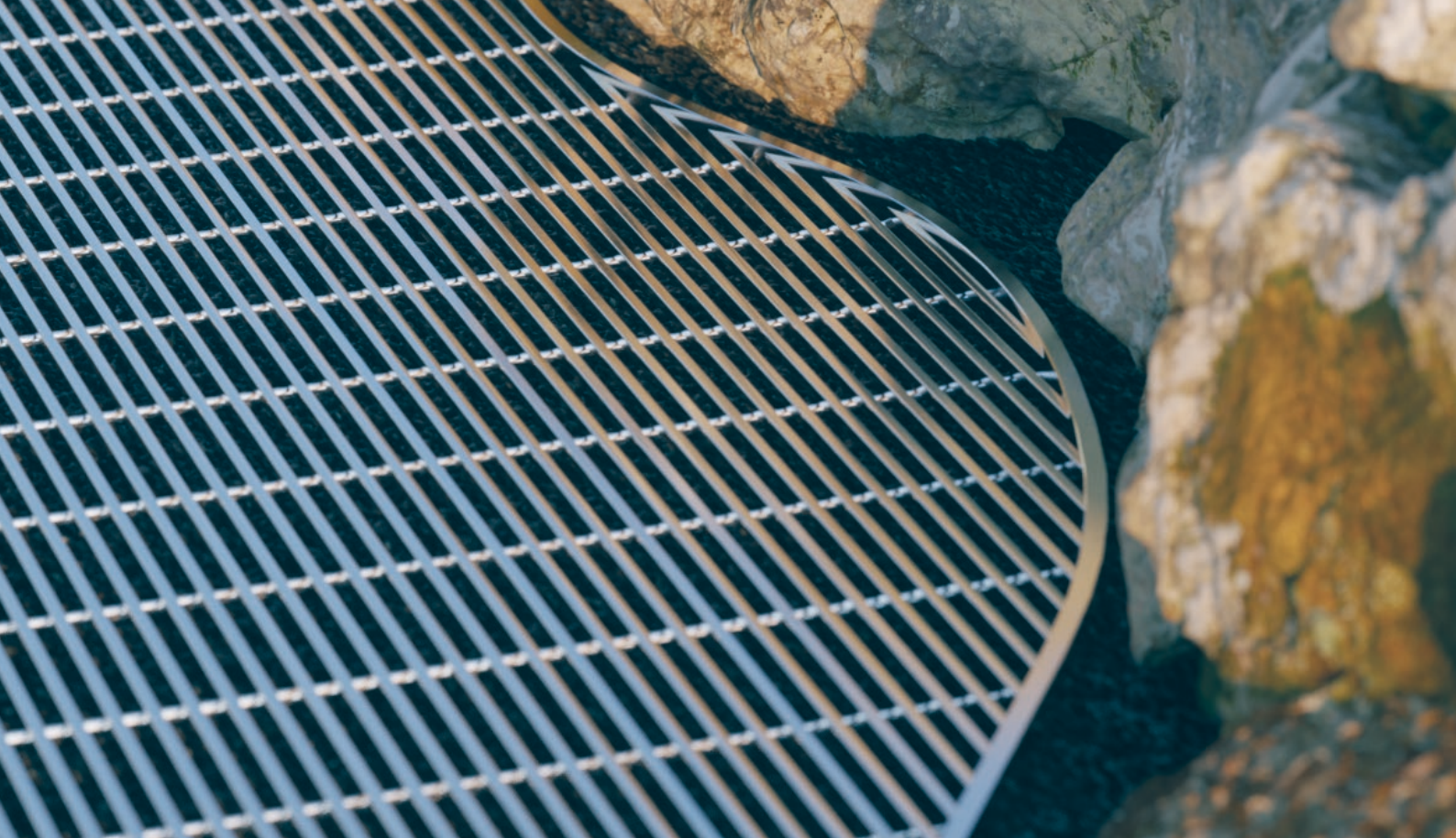

Gratings, railings, and fences

Strong, safe, and functional – aesthetically pleasing

Our gratings, railings, and security fences can easily be integrated into all types of construction: wood, concrete, stone, glass, and steel. The various profiles available, and the support fixtures that hold them, can be combined to achieve an aesthetic look with total functionality.

The profile wires and supporting rods are contact welded at every junction for strength. For each project, the profile design, load, open area and the fixtures are calculated based on your needs and our ability to

manufacture in a safe and cost-effective manner. Based on functional and aesthetic requirements, a specific open area (slot) between profile wires can be achieved without requiring additional expensive manufacturing.

Hand cuts, water jet cuts, and curved wire shapes are all in the realm of possibility to achieve a particular design vision. Frames and fixtures can be prepared to enable ready-to-install gratings. We stand ready to assist you choosing the perfect solution for your project.





Security fence



Floor grating



Claddings, visual covers, and sun protection

Ideal design elements for creating a new space

This ability to create a "second skin" to alter the visual appearance of base materials is an important capability. That is perhaps why facade elements and cladding made of stainless steel wedge wire represent the bulk of our production.

Our metal facades and visual covers have been employed worldwide by hundreds of architects to create new spaces – internally and externally – in a way that would not be possible with other materials. For example, the wedge wire profiles can be produced in sizes from very thin to thick, depending on the structural

requirements and the desired translucency. They can even be produced with variable spacing within the form to reveal a progression from virtually closed to largely open.

In addition to the ability to achieve astonishing translucency from a metallic facade, the material is tremendously versatile and can be produced in virtually endless shapes and forms from flat to complex. The right degree of transparency, the ability to filter and direct light intensity, and structural integrity are all hallmarks of our facades and cladding materials.





External cladding



Sliding sun screen detail



Interior enhancements

Flexibility in design and manufacturing provides opportunities

One of the advantages of combining versatile materials with computerized cutting and manufacturing capabilities is the potential to be flexible in the products you produce.

That depends, of course, on having skilled people on staff with a customer-centered focus on staff to collaborate with – people who ask, “What if?” and love the challenge of bringing your basic ideas into reality. The quality of the base metal and the high strength of the individually welded connections provide the foundation for great interior design. And, great design ideas can be turned into great products – light posts and fixtures, speaker covers, handrails, columns, furniture counters, etc.

Quite often, the combination of contemporary stainless steel, glass, and concrete elements together with traditional building materials can form the basis of a pleasing association. Our products can be made to appear virtually transparent and restrained or, alternatively, have a strong visual presence. This synthesis of several design elements in one material allows visual presentation and architectural integrity to fully complement the vision of the designer.

Your ideas inspire us! Let’s discuss what you would like to do and how we can make it.





Ventilation columns

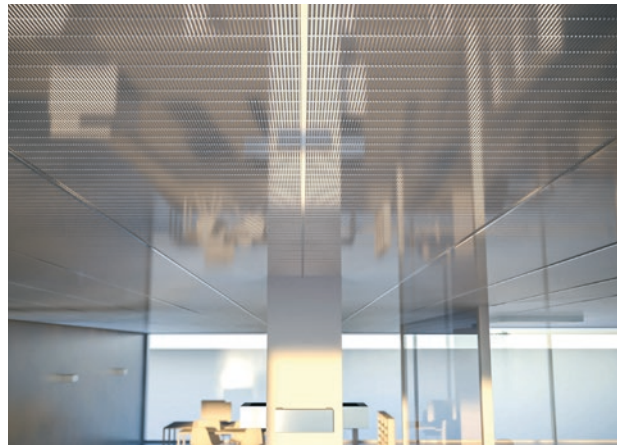

Column panels assembly





Ventilation covers

Engineered for air movement – built for beauty

With over 20 years of experience designing and manufacturing ventilation covers in a variety of styles and finishes, we are one of the best choices as a supplier/partner.

The creative potential is huge. Whether the mounting is on the floor, wall, ceiling, or even as a standalone element – horizontal, vertical, or slanted – there is sure to be a cover with the style and finish to match the look of any room.

Our engineering specialists match the design to fulfill requirements for open area, air flow, and fixture connections. The knowledge and experience of our international team should bring you confidence and assurance that the project will be done right the first time.





Ventilation floor grille

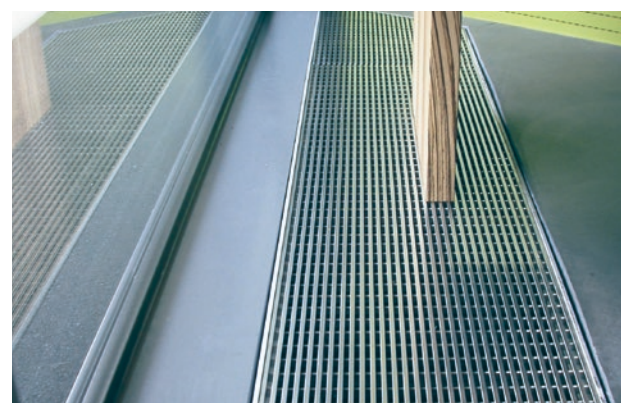
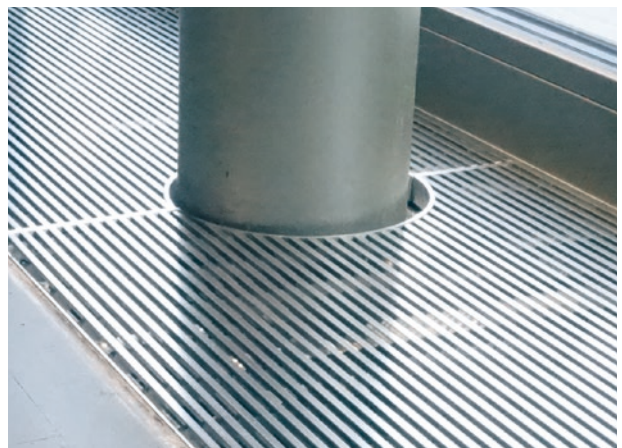

Linear floor grille assembly

A variety of profiles, frames, shapes, and finishes

Just clever technical solutions

Most of the products we manufacture are made to order from stainless steel in either flat or cylindrical form. For most architectural elements, we recommend choosing a flat panel where the profile wire and supporting rods are at right angles to each another. This provides maximum strength and stability.

For certain applications, cylindrical production is called for where the profile wire is wound in a spiral fashion around the supporting rods. Depending upon

the selected spacing of the wires, the spiral will have a defined gradient. In general, components can be manufactured to a maximum size of 2,4 meters in the profile wire direction and 3,2 meters in the supporting rod direction. Cylinders are produced in a variety of gradients to a maximum diameter of 956 mm.

The color and finish of the product is accomplished with an electrolytic polishing process. Various finishes and colors are available.

The special triangular profile wires are welded with an arbitrary distance to the support rods. The distance of the support rods is set to specific values (25, 50, 75 or 100 mm) due mechanical limits.

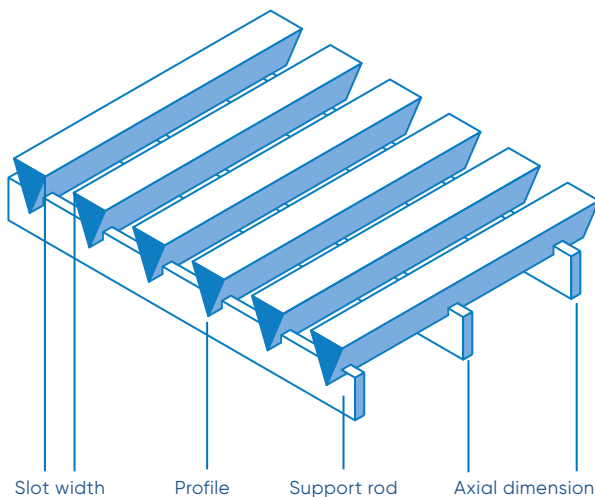

PROFILE WIRES







WIRE	SB150	P223	P300	P506
Width (mm)	1,52	2,28	3,00	5,00
Height (mm)	6,03	3,55	4,62	6,00
Weight (g/m)	20	45	79	144

This table shows a selection of our most commonly used profiles and dimensions. Special profile wires and support rods are available upon request.





SUPPORT RODS

ROD	Q35	I102c	I152c	I252c	I352c	I403c
						
Width (mm)	3,00	2,00	2,00	2,00	2,00	3,00
Height (mm)	5,00	10,00	15,00	25,00	35,00	40,00
Weight (g/m)	100	160	240	390	550	960

Designs

Standard designs – or customized

The elegance of wedge wire components is achieved through precise computer-controlled manufacturing processes. Rather than being a constraint, the accuracy and repeatability of computer control increases the variety of options available to adapt a product to its application.

We offer four standard styles, each varying slightly in profile wire width and support rod height to achieve a specific look and functionality.

The profile wires and supporting rods are resistance welded at every junction for strength.

INDIVIDUAL DESIGNS WITHOUT ADDITIONAL COSTS

For higher volume orders (consult with our specialists), we can customize the grid style to achieve a different pitch, different profile wire, or a different space between wires to meet your specific requirements.

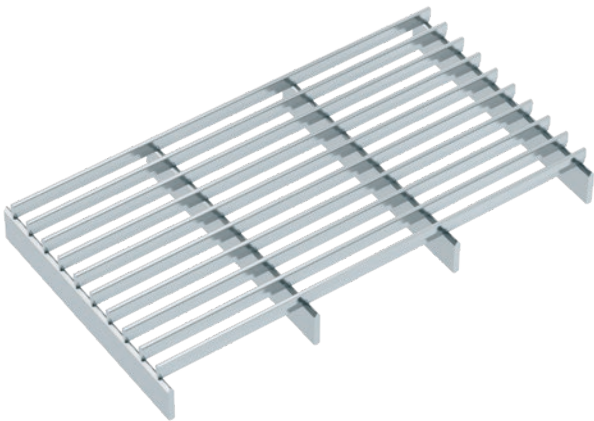

EUROSLOT Series B150

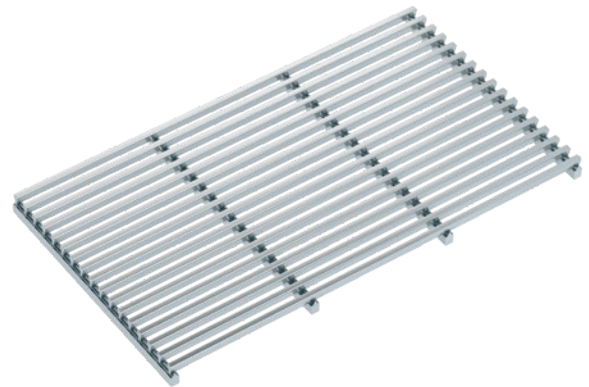

EUROSLOT Series 220

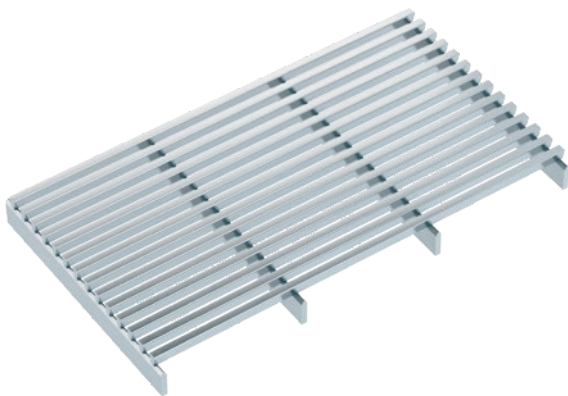

EUROSLOT Series 300

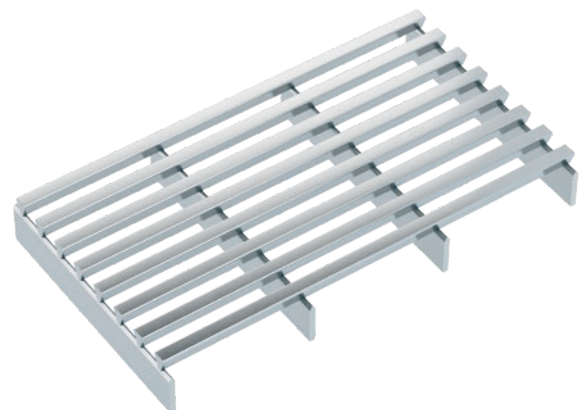

EUROSLOT Series 560

Frames

The perfect finish

We offer several different frame styles to surround the wedge wire grids. Depending on requirements, the grids can either be welded or locked to the frame.



Flachrahmen mit Konterrahmen

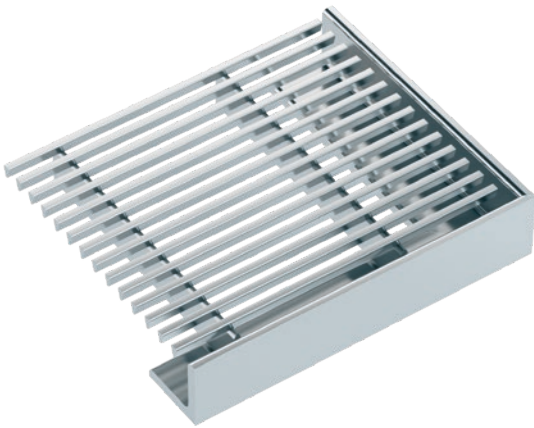

L-frame, grid inserted unfixed

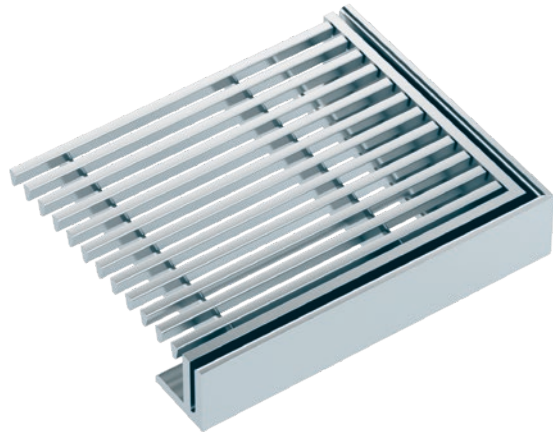

Double frame

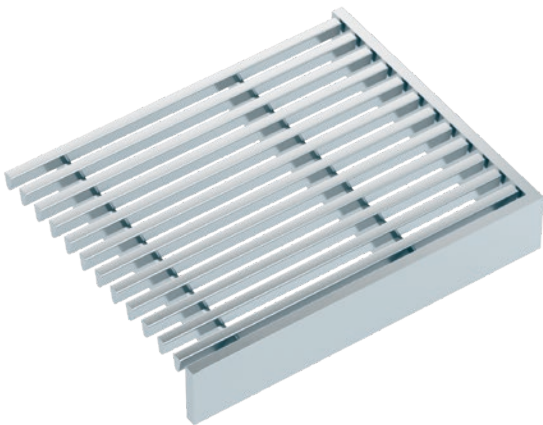

Flat frame welded on grid



L-frame welded on grid

Your vision taking form

You imagine it – we produce it

Our products have a common foundation: high quality material, computer-precise profile wires and support rods, and high-strength individually welded connections. These are the building blocks that we

use to shape our products in virtually any form to fully complement the vision of the designer. Examples of the forms our products can take are found on these pages.

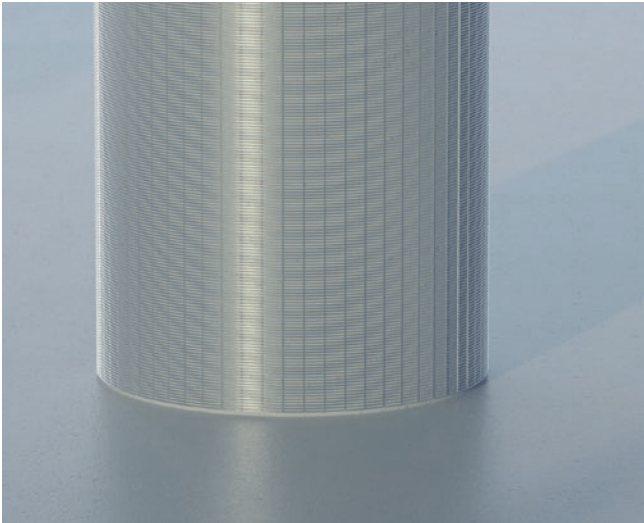

Cylinder



Wave form

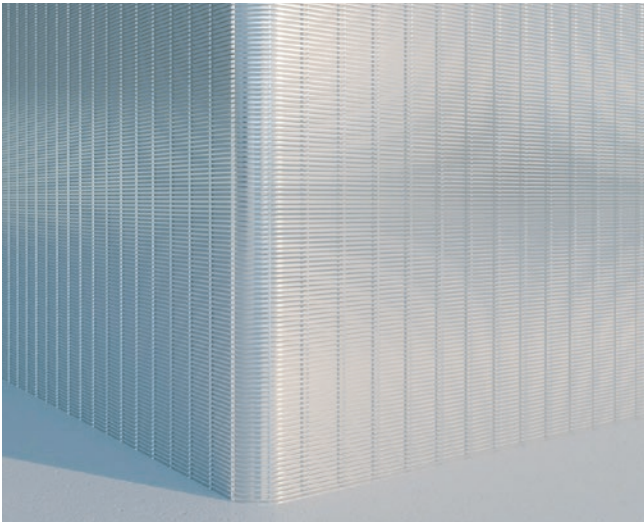

Angled



Parallelogram

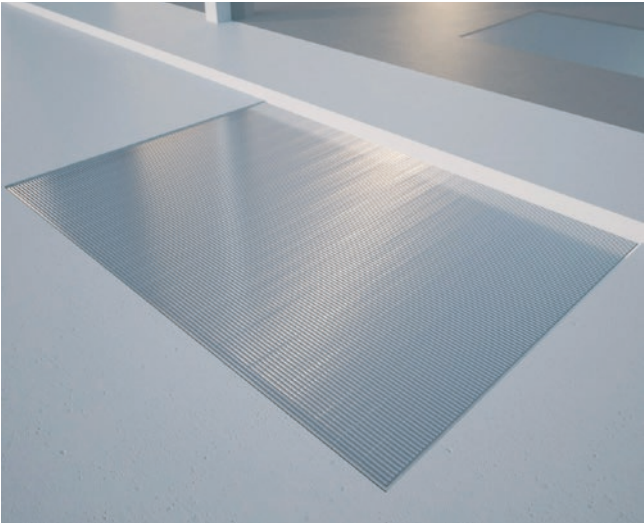

Rectangle

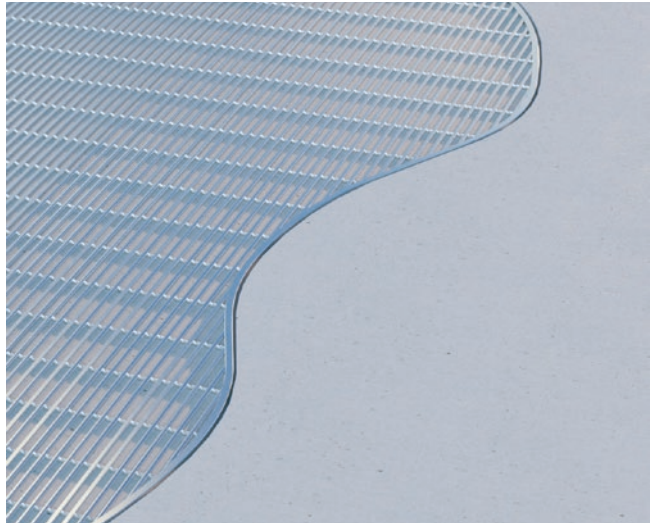

Free form

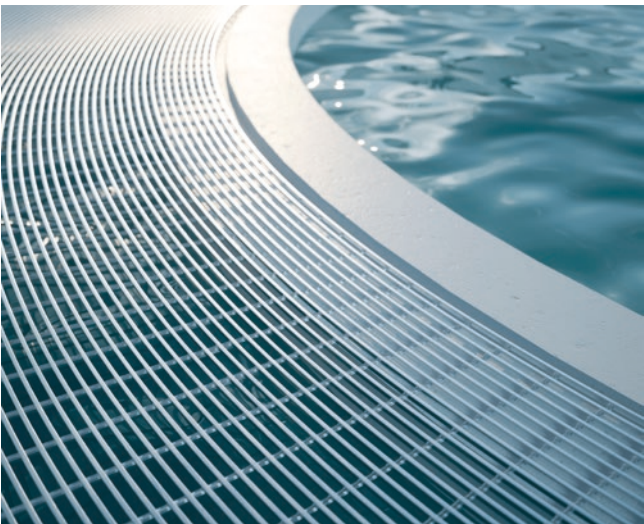

Radial grading

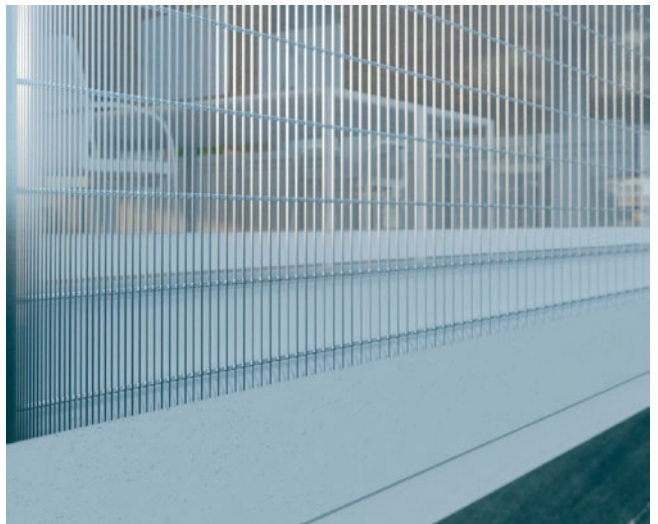

Variable slots

Finished to perfection

A rainbow of colors – a variety of finishes

We utilize an electrolytic polishing process to produce a variety of external finishes on our products: matte, brushed, or mirror. We can color-match the grids to any color, from matte black to glimmering chamagne.

Grids for applications such as gratings or stairs can also be finished with a special anti-slip surface. Common finishes are shown on these pages.

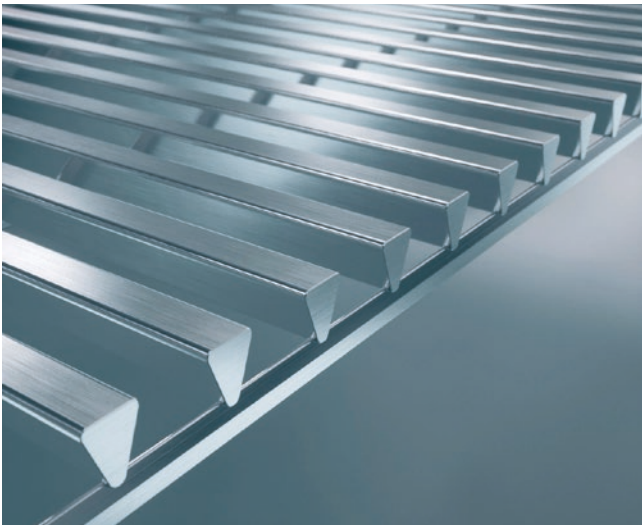

Natural satin finish. Pickled and passivated satin finish

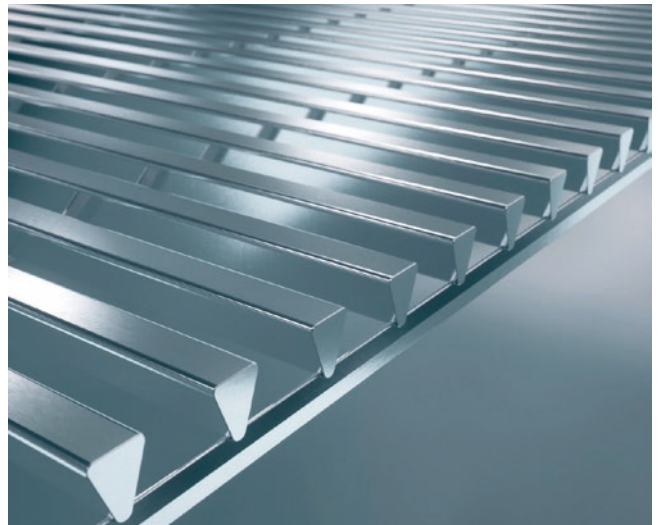

Electropolished

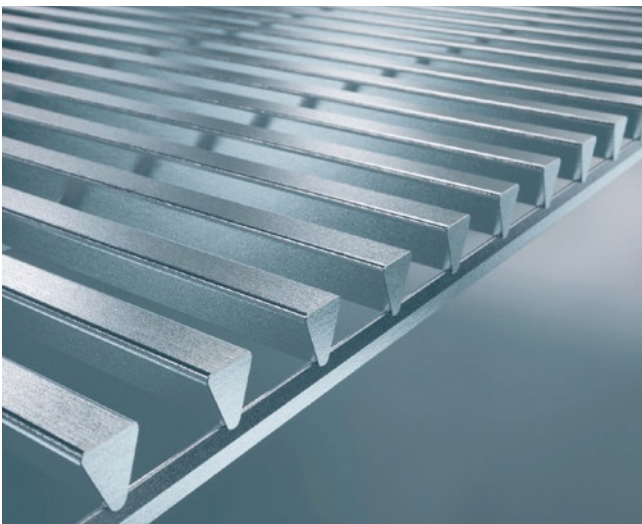

Anti-slip surfacing

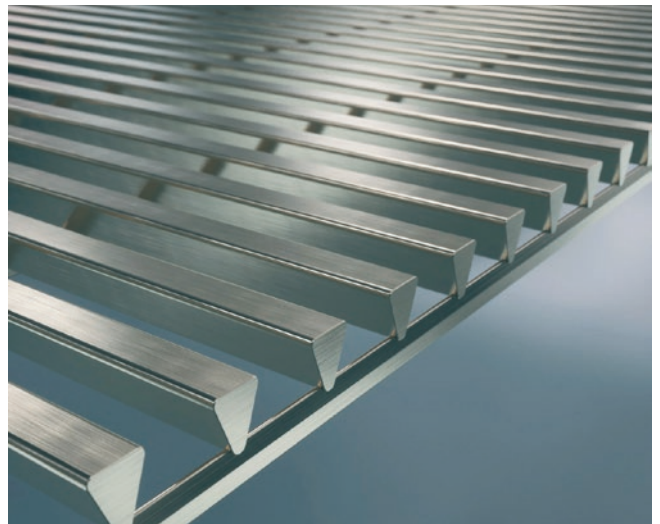

Colored



Interior natural satin finish



Ventilation grille

Fixtures and connectors

For ease of installation

We offer common commercial fixtures and connection systems to attach the wedge wire lattice structures to building walls and ceilings. We can often weld the grids to the fixtures for easier bolt-on installation at the project site.

We work closely with designers and constructors to recommend and deliver the safest, easiest, and most cost-effective method to install our wedge wire products.

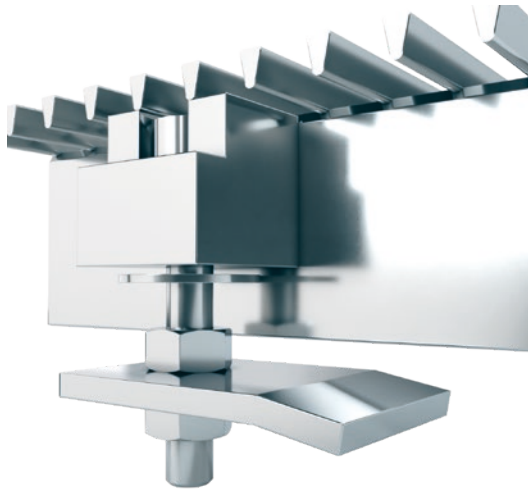

Anti-vandalism, gets locked with a screw below the grid

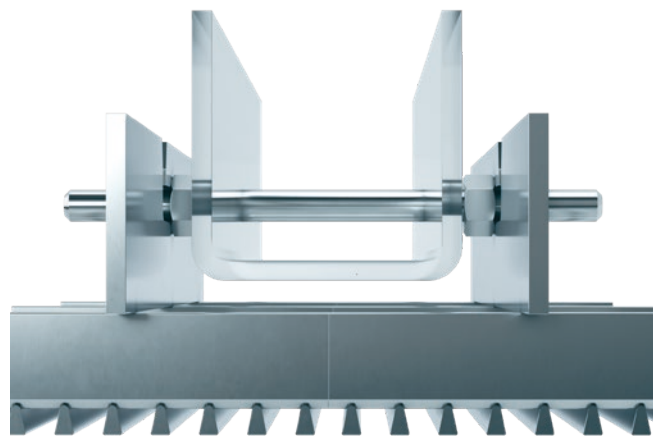

Hooked-on solution transverse to rod



Hooked-on solution parallel to rod

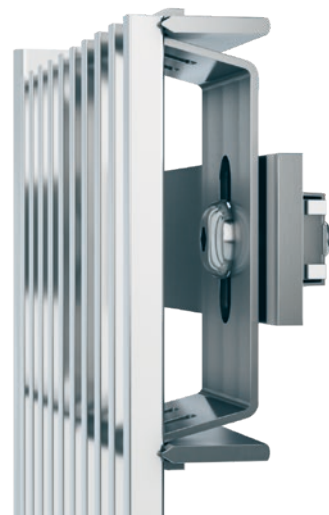

Removable fixing clip



Welded plate

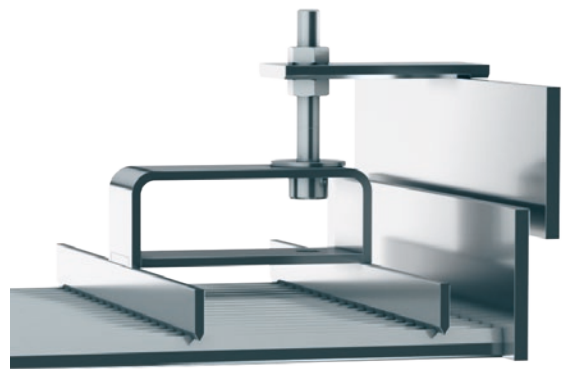

Ceiling fixation

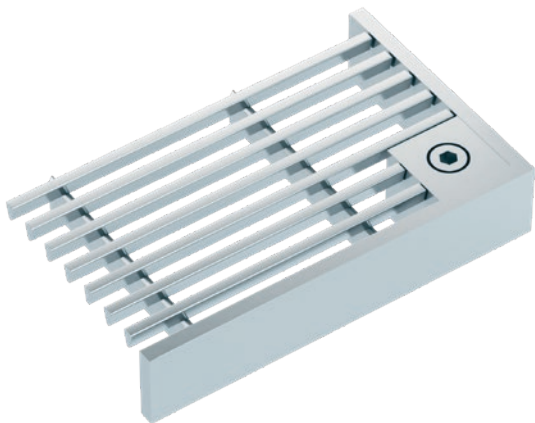

Screw fixation square



Screw fixation round



A WORLD OF SEPARATION SOLUTIONS

ANDRITZ provides mechanical and thermal solid/liquid separation technologies, complemented by comprehensive services, automation, and digitalization solutions for the chemicals, environment, food and beverage, as well as mining and minerals industries. Our customized, innovative solutions focus on minimizing resource consumption and maximizing process efficiency, thus making a substantial contribution towards sustainable environmental protection. With over 150 years of experience and more than 2,700 separation specialists around the globe, we are a driving force in the evolution of separation solutions – enabling industries to meet tomorrow's demands responsibly. **ANDRITZ. FOR GROWTH THAT MATTERS.**

AFRICA

ANDRITZ Delkor (Pty) Ltd.
p: +27 11 012 7300
separation.za@andritz.com

EUROPE

ANDRITZ Euroslot SAS
p: +33 549 93 93 93
info-euroslot@andritz.com

ASIA

ANDRITZ Singapore Pte. Ltd.
p: +65 6512 1800
separation.sg@andritz.com

NORTH AMERICA

ANDRITZ Separation Inc.
p: +1 817 465 5611
separation.us@andritz.com

AUSTRALIA

ANDRITZ Pty. Ltd.
p: +61 3 8773 4888
separation.au@andritz.com

SOUTH AMERICA

ANDRITZ Separation Ltda.
p: +55 47 3387 9100
separation.bra@andritz.com

CHINA

ANDRITZ (China) Ltd.
p: +86 757 8258 6802
separation.cn@andritz.com

[ANDRITZ.COM/ARCHITECTURE](https://www.andritz.com/architecture)

JOIN US ON SOCIAL MEDIA



ANDRITZ

All data, information, statements, photographs and graphic illustrations in this brochure are without any obligation and raise no liabilities to or form part of any sales contracts of ANDRITZ AG or any affiliates for equipment and/or systems referred to herein. © ANDRITZ Group 2026. All rights reserved. No part of this copyrighted work may be reproduced, modified or distributed in any form or by any means, or stored in any database or retrieval system, without the prior written permission of ANDRITZ AG or its affiliates. Any such unauthorized use for any purpose is a violation of the relevant copyright laws. ANDRITZ AG, Stattegger Strasse 18, 8045 Graz, Austria. CB Architecture 2.0/04.2026